

Diamond core drill bits

Husqvarna VARI-DRILL D20

Silver



Optimal

Concrete hard, Natural stone



Good

Concrete medium, Brick



Acceptable

Concrete soft, Green concrete (abrasive)
hard, Green concrete (abrasive) soft

Fits to

DM 220

DM 650

DMS 240

DM 406 H

DM 230

DM 430

Article Number : 582 00 56-01



Ташев-Галвинг ООД
www.tashev-galving.com

FEATURES

Want to take a closer look? Learn more about the product in depth by exploring its features and benefits.

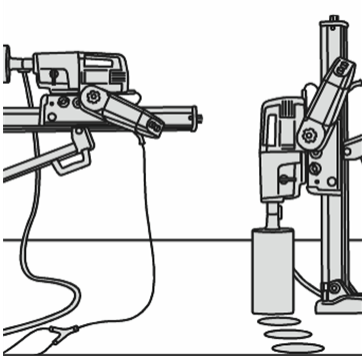

Heavy-duty applications

For heavy-duty applications like water evacuation, ventilation and plumbing channels, waste evacuation pipes, gas supply pipes and barriers.

Ideal for concrete and hard materials

Developed for fast cutting in universal construction materials, with a focus on hard materials like granite and hard concrete.

Laser welded

Segments are attached to the tube by laser welding to minimise the risk of segment loss.

Several smart accessories available

With accessories such as adapters, centering devices and extenders the drill job can be made easier.

RECOMMENDED MATERIALS FOR VARI-DRILL D20

●●● Optimal

Concrete hard Natural stone

●● Good

Concrete medium Brick

● Acceptable

Concrete soft Green concrete (abrasive) hard Green concrete (abrasive) soft

Fits to

DM 220

DM 650

DMS 240

DM 406 H

DM 230

DM 430